

Quick start guide

Schnellstartanleitung / Guide de démarrage rapide / Guida rapida /

Guía de inicio rápido / Snabbstartsguide / Snelstartgids /

Vejledning til hurtig start / Hurtigstartveiledning / Pikaopas /

Stručná příručka / Skrócona instrukcja obsługi / Gyorsútmutató



neato



What's in the box

Lieferumfang / Contenu de la boîte / Contenuto della confezione /
Contenido de su caja / Vad ingår i förpackningen / Inhoud van de doos / Kassens indhold /
Dette er i boksen / Pakkauksen sisältö / Obsah krabice /
Zawartość opakowania / A doboz tartalma

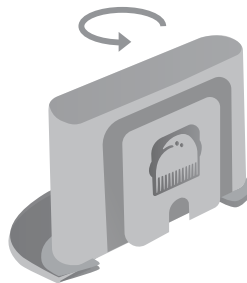
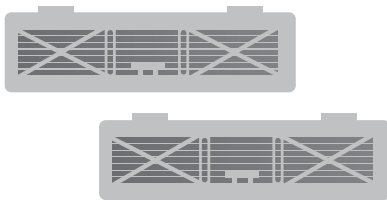
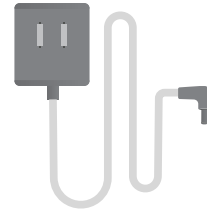

Quick start guide

- 1 Insert plug behind the charge base. Shorten the cord as needed by wrapping it behind the charge base.

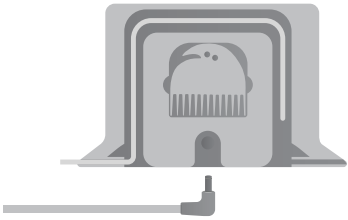

- 2 Select a clear area with good Wi-Fi coverage. Make sure the charge base is against the wall and plugged in.

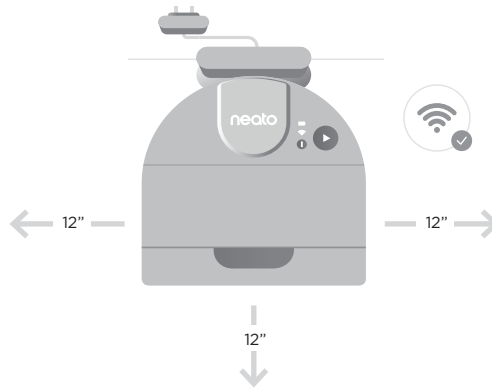

- 3 Place the robot against the charge base. When docked properly, the battery icon will light up.

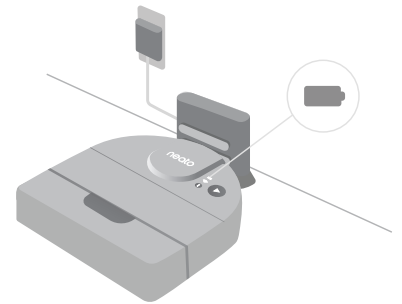

- 4 Download the MyNeato application.

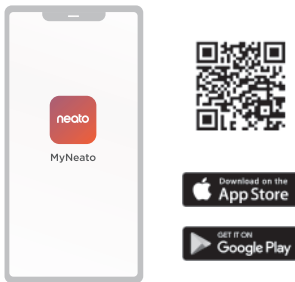

- 5 Check your mobile device setting to make sure the Bluetooth is switched on.

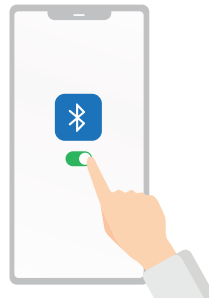

- 6 Finish your set up process with the MyNeato application.



Helpful hints

Set up your house

Before the robot starts to vacuum, pick up items that could become tangled, such as cables, socks, and shoelaces. Tuck fringes under rugs.

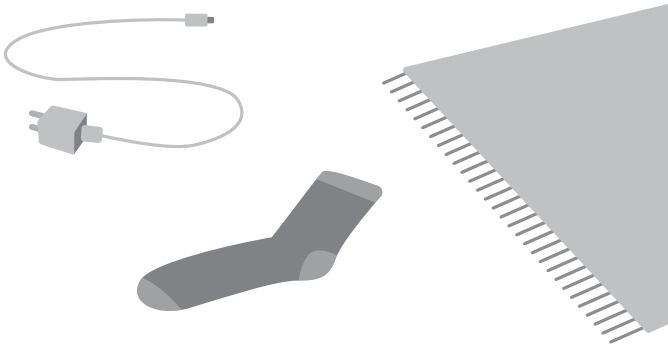

Keep your charge base secure

Your charge base comes with a pad designed to keep it secure on a hardwood floor. Remove these pads if you plan to place the charge base on carpet.

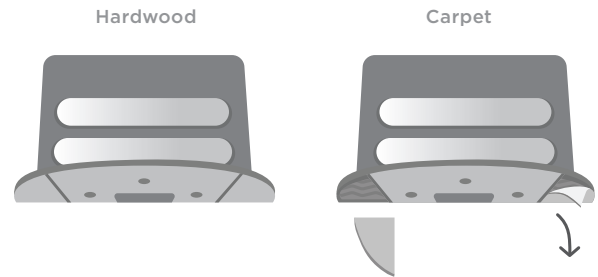

Clean with the MyNeato app

Use the MyNeato app to:

- Schedule your robot
- View cleaning maps
- Create No-Go Zones



Need assistance?

Learn more about your robot:
www.NeatoRobotics.com/UG

We are here to help. Contact us at:
www.NeatoRobotics.com/contact-us



Schnellstartanleitung

- 1 Den Stecker hinter der Ladestation einstecken. Das Kabel nach Bedarf kürzen, indem Sie es hinter der Ladestation aufwickeln.

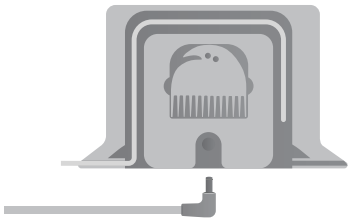

- 2 Wählen Sie einen freien Bereich mit guter WLAN-Abdeckung. Stellen Sie sicher, dass die Ladestation an der Wand steht und eingesteckt ist.

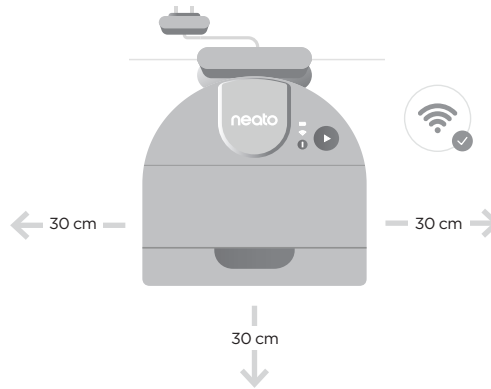

- 3 Stellen Sie den Roboter an die Ladestation. Wenn er richtig angedockt ist, leuchtet das Batteriesymbol auf.

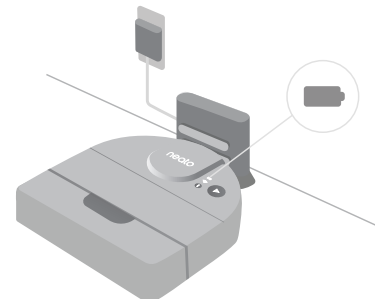

- 4 Die MyNeato-App auf Ihr mobiles Endgerät herunterladen.



- 5 Überprüfen Sie in den Einstellungen auf Ihrem mobilen Endgerät, dass Bluetooth eingeschaltet ist.

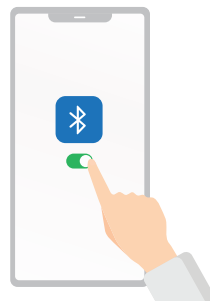

- 6 Schließen Sie Ihren Einrichtungsprozess mit der MyNeato-App ab.



Nützliche Hinweise

Bereiten Sie Ihr Haus vor

Sammeln Sie, bevor der Roboter mit dem Staubsaugen beginnt, alle Gegenstände auf, die sich verfangen könnten, wie Kabel, Socken oder Schnürsenkel. Stecken Sie die Teppichfransen unter die Teppiche.

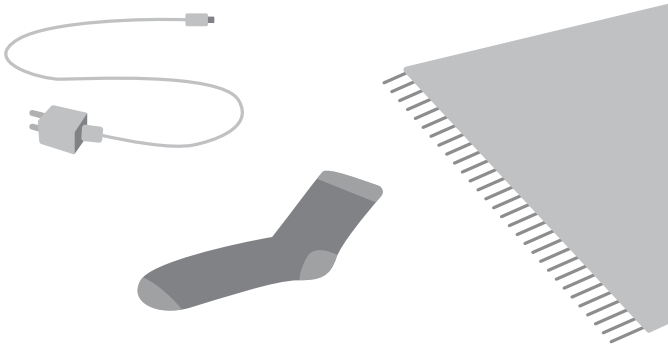

Sichern Sie Ihre Ladestation

Ihre Ladestation ist mit einer Unterlage ausgestattet, damit sie sicher auf einem Parkettboden steht. Entfernen Sie diese Unterlage, wenn Sie die Ladestation auf einem Teppich stellen möchten.

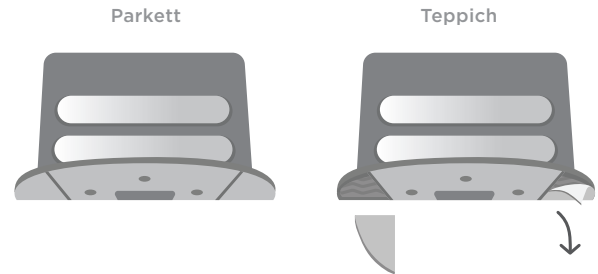

Mit der MyNeato-App reinigen

Sie können die MyNeato-App für Folgendes nutzen:

- Zeitplan für Ihren Roboter festlegen
- Reinigungskarten anzeigen
- Legen Sie No-Go Zonen



Benötigen Sie Hilfe?

Erfahren Sie mehr über den Roboter:
www.NeatoRobotics.com/UG

Wir helfen gerne weiter.
Kontaktieren Sie uns unter
www.NeatoRobotics.com/contact-us

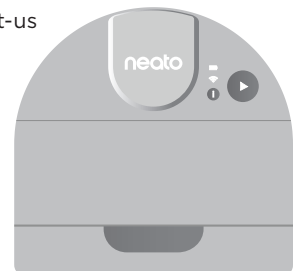

Guide de démarrage rapide

- 1 Insérez la fiche à l'arrière de la base de chargement. Raccourcissez le cordon selon vos besoins en l'enroulant derrière la base de chargement.

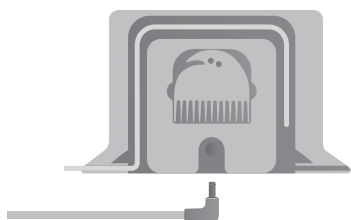

- 2 Choisissez un espace dégagé avec une bonne couverture Wi-Fi. Assurez-vous que la base de chargement est contre le mur et branchée.

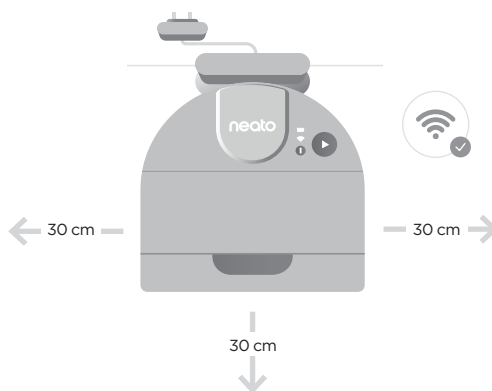

- 3 Placez le robot contre la base de chargement. Lorsqu'elle est correctement connectée, l'icône de la batterie s'allume.

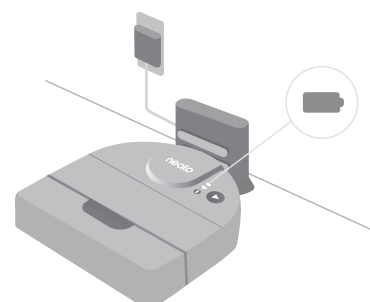

- 4 Téléchargez l'application MyNeato sur votre appareil mobile.

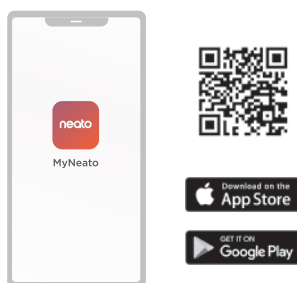

- 5 Vérifiez le réglage de votre appareil mobile pour vous assurer que la fonction Bluetooth est activée.

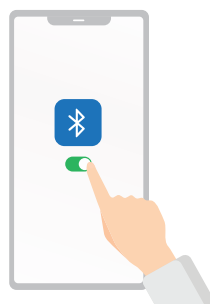

- 6 Utilisez l'application MyNeato pour.



Conseils utiles

Préparez votre maison

Avant que le robot ne démarre le nettoyage, rangez les objets pouvant le gêner, comme les câbles, les chaussettes et les lacets de chaussures. Placez les franges de tapis sous les tapis.

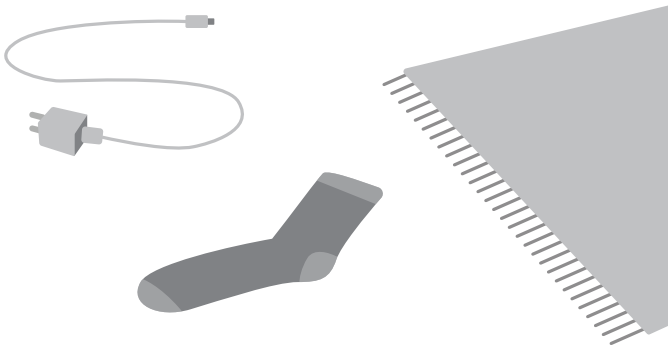

Protégez votre base de chargement

Votre base de chargement est fournie avec un coussinet conçu pour la protéger lors d'une utilisation sur un sol en bois dur. Retirez ce coussinet si vous prévoyez de placer la base de chargement sur une moquette.

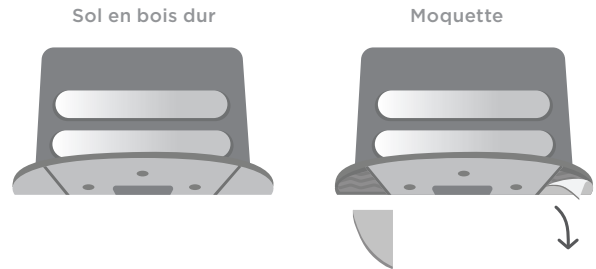

Nettoyer avec l'application MyNeato

L'appareil de nettoyage par excellence:

- Programmer votre robot
- Voir les cartes de nettoyage
- Créez des zones de délimitation

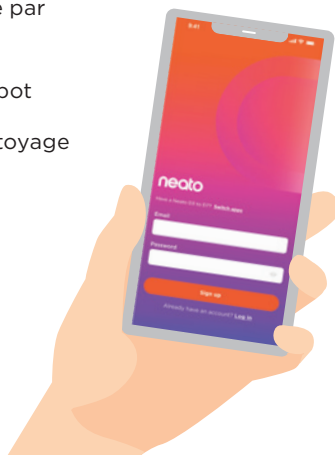

Besoin d'aide ?

Pour en savoir plus sur votre robot, rendez-vous sur www.NeatoRobotics.com/UG

Nous sommes là pour vous aider. Pour en savoir plus, rendez-vous sur www.NeatoRobotics.com/contact-us



FRANÇAIS

Guida rapida

- 1 Inserire la spina dietro la base di carica. Accorciare il cavo quanto è necessario avvolgendolo dietro la base di carica.

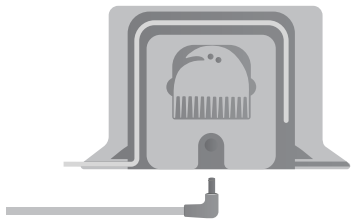

- 2 Selezionare un'area libera con una buona copertura Wi-Fi. Accertarsi che la base di carica sia appoggiata contro il muro e collegata.

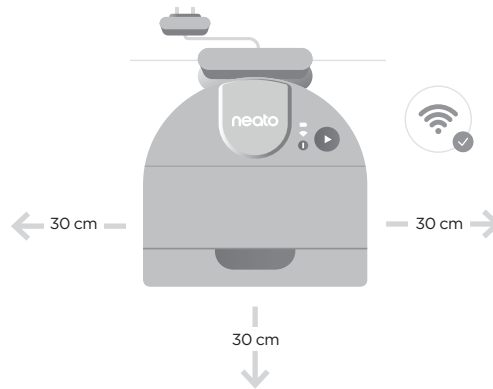

- 3 Appoggiare il robot alla base di carica. Una volta agganciato in modo appropriato, l'icona della batteria si accenderà.

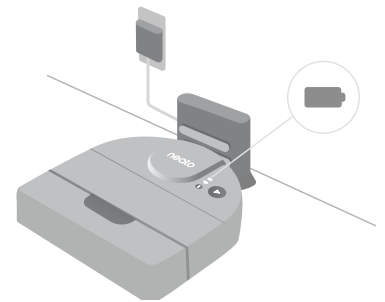

- 4 Scaricare l'applicazione MyNeato sul proprio dispositivo mobile.

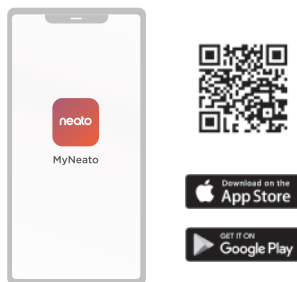

- 5 Verificare le impostazioni del dispositivo mobile per verificare che la funzione Bluetooth sia attiva.

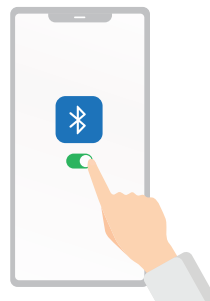

- 6 Termina il processo di configurazione con l'applicazione MyNeato.



Suggerimenti utili

Preparazione della casa

Prima che il robot inizi la pulizia, raccogliere eventuali oggetti che potrebbero rimanere intrappolati, come cavi, calze o lacci da scarpe. Ripiegare le frange sotto i tappeti.

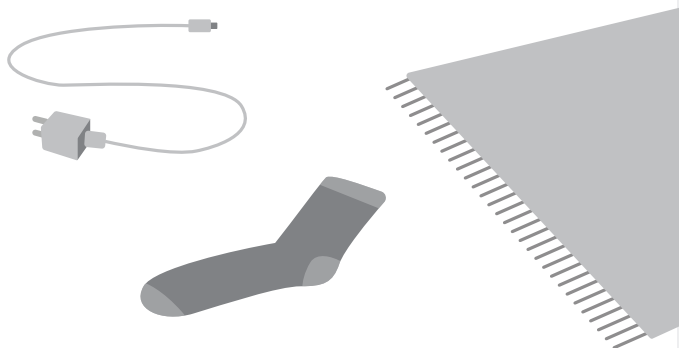

Mantieni sicura la tua base di carica

La tua base di carica è dotata di un cuscinetto progettato per mantenerla sicura su un pavimento in legno duro. Rimuovi questi tamponi se prevedi di posizionare la base di carica sulla moquette.

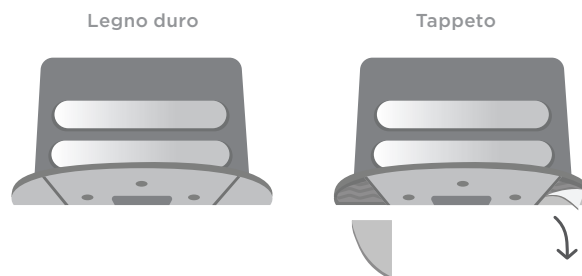

Pulizia con l'app MyNeato

Usa l'app MyNeato per:

- Programma il robot
- Visualizza le mappe della pulizia
- Crea zone di demarcazione



Serve aiuto?

Per saperne di più sul tuo robot:
www.NeatoRobotics.com/UG

Siamo qui per aiutarti. Contattaci alla pagina
www.NeatoRobotics.com/contact-us



Guía de inicio rápido

- 1 Enchufe el conector en la parte posterior de la base de carga. Acorte el cable según sea necesario enrollándolo detrás de la base de carga.

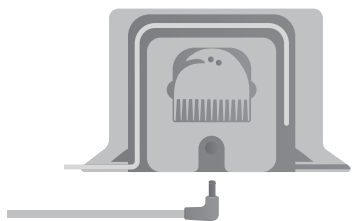

- 2 Seleccione un área despejada con buena cobertura Wi-Fi. Asegúrese de que la base de carga esté contra la pared y enchufada.

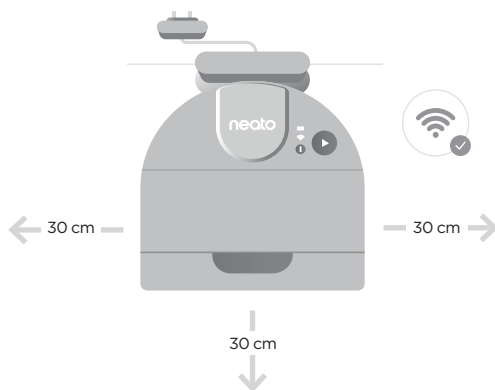

- 3 Coloque el robot contra la base de carga. Cuando está acoplado correctamente, el icono de la batería se enciende.

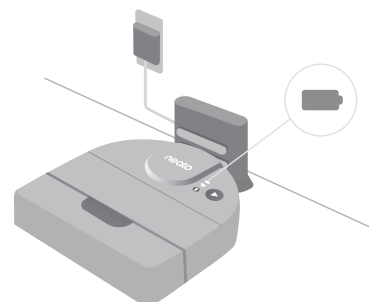

- 4 Descargue la app MyNeato en su dispositivo móvil.

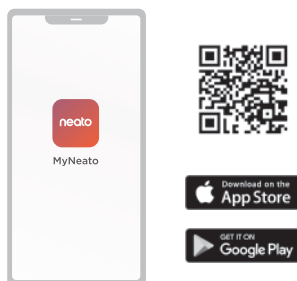

- 5 Compruebe la configuración de su dispositivo móvil para asegurarse de que Bluetooth esté activado.

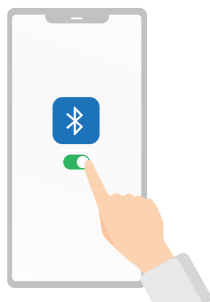

- 6 Termine su proceso de configuración con la aplicación MyNeato.

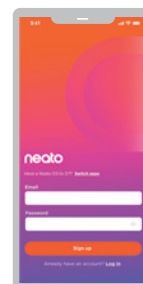

Consejos útiles

Prepare la casa

Antes de que el robot comience a aspirar, guarde cualquier elemento que pueda enredarse, como cables, calcetines y cordones. Doble los flecos por debajo de las alfombras.

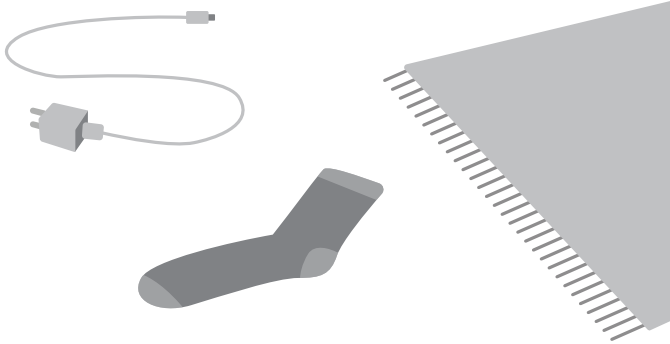

Mantenga segura su base de carga

Su base de carga va acompañada de una almohadilla diseñada para mantenerla protegida de los suelos de madera dura. Retire la almohadilla si tiene previsto colocar la base de carga en una moqueta.

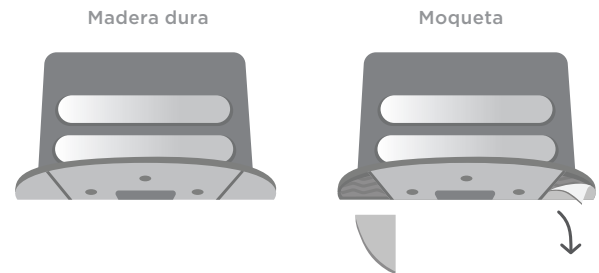

Limpie desde la app MyNeato

Utilice la aplicación MyNeato para:

- Programe su robot
- Visualice mapas de limpieza
- Cree zonas limite

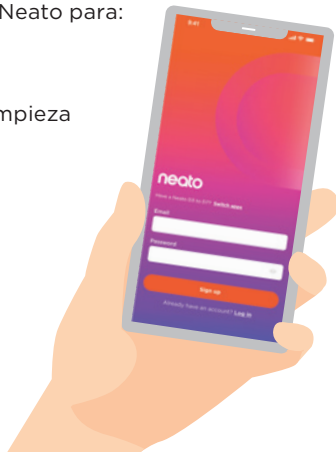

¿Necesita asistencia?

Más información acerca de su robot:
www.NeatoRobotics.com/UG

Estamos aquí para ayudar. Póngase en contacto con nosotros a través de
www.NeatoRobotics.com/contact-us

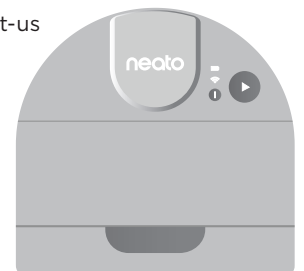

Snabbstartsguide

- 1 Sätt i kontakten bakom laddningsstationen. Förkorta sladden efter behov genom att linda den bakom laddningsstationen.

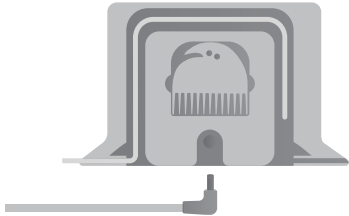

- 2 Välj ett tomt område med bra Wi-Fi-täckning. Säkerställ att laddningsstationen står mot väggen och är inkopplad.

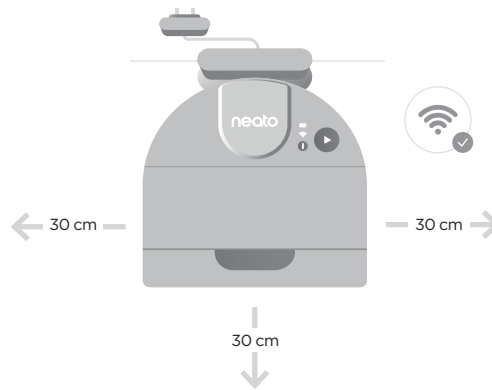

- 3 Placera roboten mot laddningsstationen. Batteriikonen tänds när roboten är ansluten korrekt.

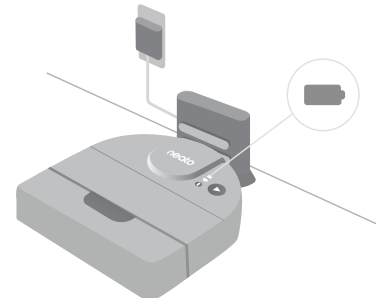

- 4 Hämta MyNeato-appen på din mobila enhet.



- 5 Kontrollera inställningarna i din mobila enhet för att säkerställa att Bluetooth är aktiverat.

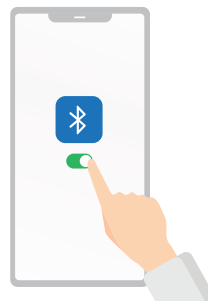

- 6 Slutför konfigurationen med MyNeato-appen.



Hjälpsamma tips

Förbered hemmet

Plocka upp saker som kan fastna, till exempel kablar, strumpor och skosnören innan roboten börjar dammsuga. Stoppa in fransarna under mattorna.

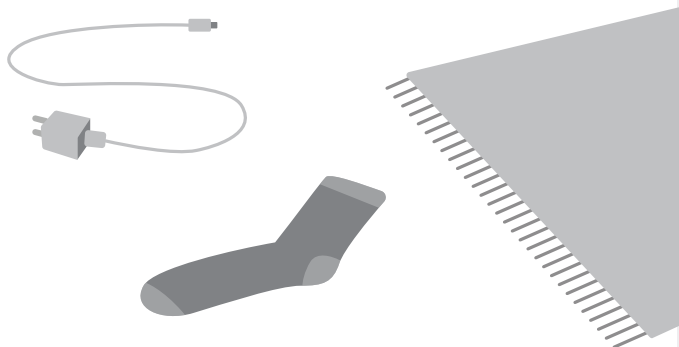

Håll din laddningsstation säker

Laddningsstationen har ett underlag som är utformat för att den ska stå säkert på hårda golv. Ta bort detta underlag om du tänker ställa laddningsstationen på en matta.

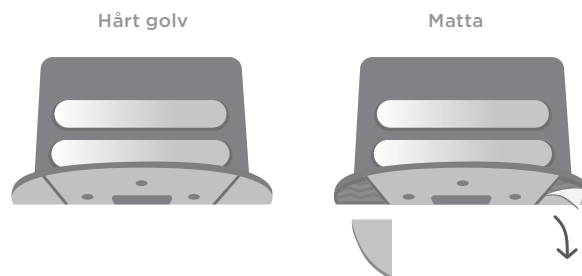

Städa med MyNeato-appen

Använd MyNeato-appen till:

- Schemalägg din robot
- Visa städkartor
- Skapa No-Go zoner

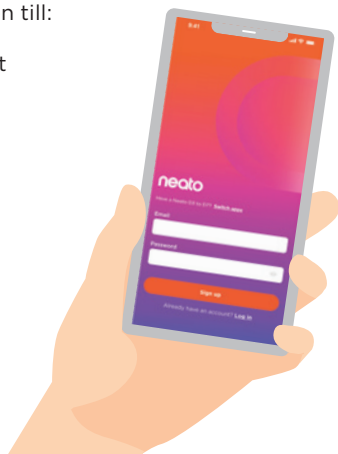

Behöver du hjälp?

Läs mer om din robot:
www.NeatoRobotics.com/UG

Vi finns här för dig. Kontakta oss på
www.NeatoRobotics.com/contact-us



Snelstartgids

- 1 Steek de stekker achter het laadstation in. Kort het snoer indien nodig in door het achter het laadstation te wikkelen.

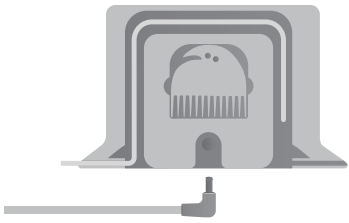

- 2 Selecteer een leeg gebied met goede Wi-Fi-dekking. Zorg ervoor dat het laadstation tegen de wand is geplaatst en is aangesloten.

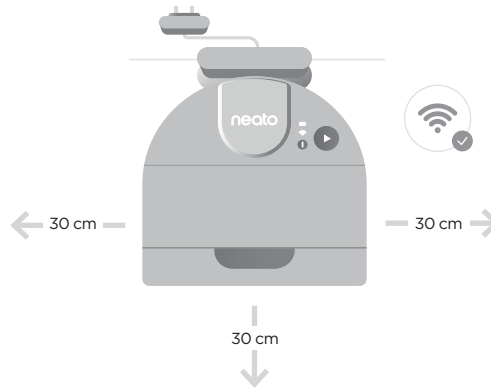

- 3 Plaats de robot tegen het laadstation. Als deze goed is gedokt, gaat het batterijpictogram branden.

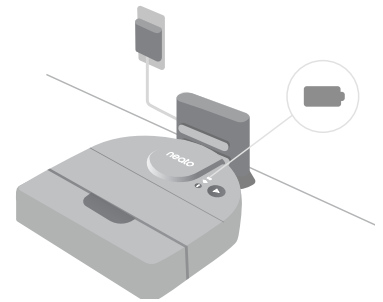

- 4 Download de applicatie MyNeato op uw mobiele apparaat.

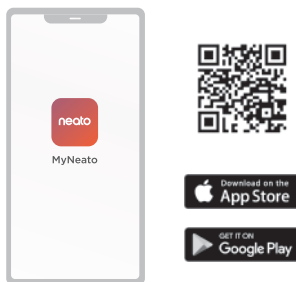

- 5 Controleer de instellingen van uw mobiele apparaat om ervoor te zorgen dat Bluetooth is ingeschakeld.

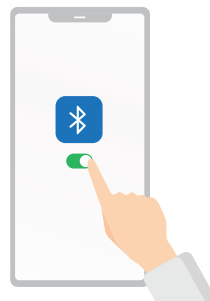

- 6 Afslut opsætningsprocessen met MyNeato-appen.



Nuttige tips

Uw woning voorbereiden

Pak voorwerpen die verstrikt zouden kunnen raken (zoals kabels, sokken en veters) op voordat u de robot laat stofzuigen. Stop franjes onder het tapijt.

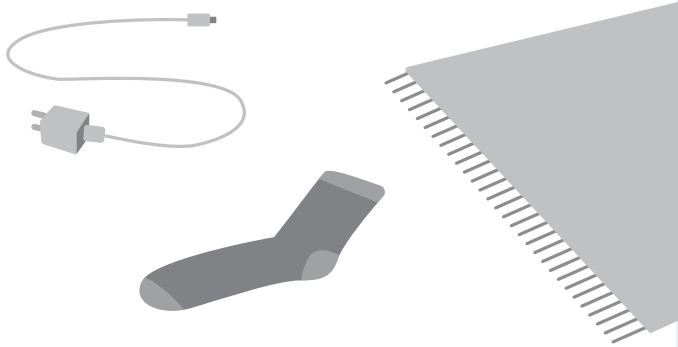

Uw laadstation veilig houden

Uw laadstation wordt geleverd met een onderlegger waarmee dit veilig op een hardhouten vloer kan worden geplaatst. Verwijder deze onderlegger als u het laadstation op een tapijt wilt plaatsen.

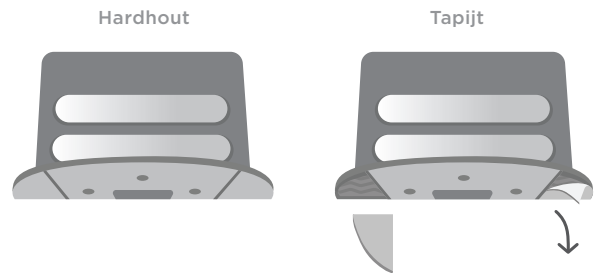

Reinigen met de MyNeato-app

Gebruik de MyNeato-app voor:

- Een planning voor uw robot maken
- Reinigingskaarten bekijken
- No Go gebieden instellen



Hulp nodig?

Meet informatie over uw robot:
www.NeatoRobotics.com/UG

Wij zijn hier om u te helpen.
Neem contact met ons op via
www.NeatoRobotics.com/contact-us

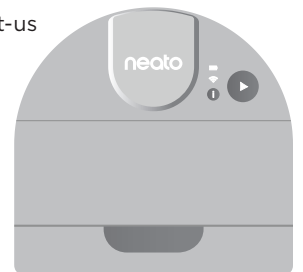

Vejledning til hurtig start

- 1 Sæt stikket i bag på opladningsstationen: Afkort kablet efter behov ved at vikle det sammen bag på opladningsstationen.

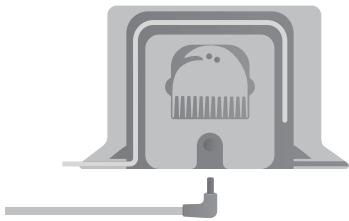

- 2 Vælg et ryddet område med god Wi-Fi-forbindelse. Sørg for, at opladningsstationen er placeret op imod væggen og tilsluttet en strømkilde.

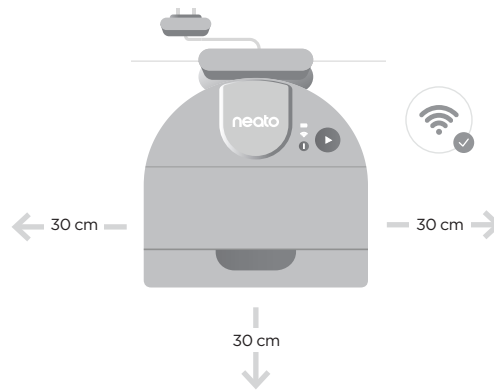

- 3 Placer robotten op mod opladningsstationen. Når den er korrekt tilsluttet, lyser batterikonet.

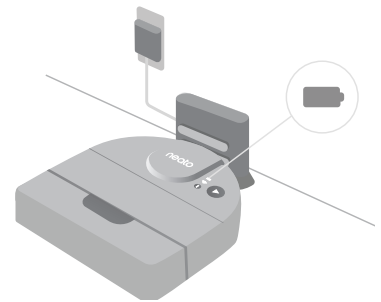

- 4 Download MyNeato-appen på din mobile enhed.

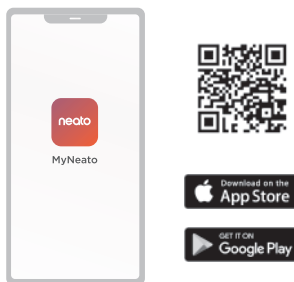

- 5 Kontrollér din mobile enheds indstillinger for at sikre dig, at Bluetooth er aktiveret.

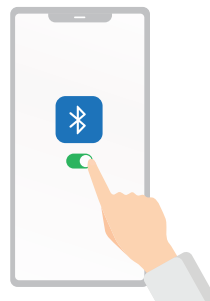

- 6 Voltooi uw instelproces met de MyNeato-toepassing.



Nyttige tips

Klargør din bolig

Inden du påbegynder støvsugning, skal du fjerne alle genstande såsom kabler, sokker og snørebånd, som kunne blive viklet ind i robotten. Fold eventuelle frynser ind under gulvtæpperne.

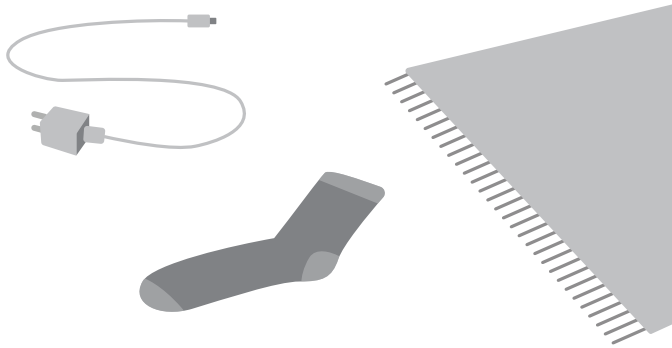

Hold din opladningsstation sikker

Der følger et underlag med til din opladningsstation, der er gør den skridsikker på trægulve. Fjern disse underlag, hvis du vil placere opladningsstationen på et tæppe.

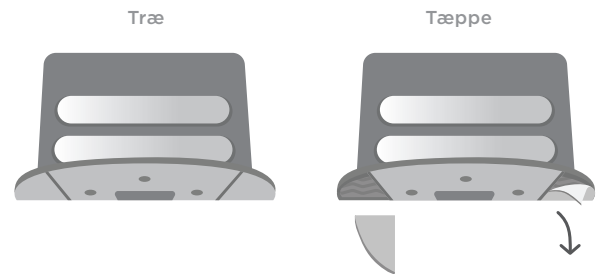

Gør rent med MyNeato-appen

Brug MyNeato-appen til at:

- Tidsindstil din robot
- Se rengøringskort
- Opret No-Go zoner



Har du brug for hjælp?

Få mere at vide om din robot på www.NeatoRobotics.com/UG

Vi står klar til at hjælpe. Kontakt os på www.NeatoRobotics.com/contact-us



Hurtigstartveiledning

- 1 Sett i støpselet bak ladebasen. Forkort ledningen etter behov ved å brette den inn bak ladebasen.

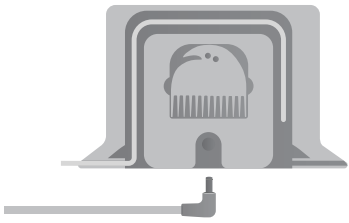

- 2 Velg et åpent område med god Wi-Fi-dekning. Sørg for at ladebasen står mot vegg og er koblet til.

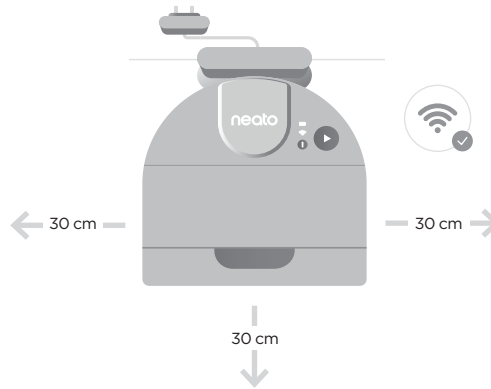

- 3 Plasser roboten mot ladebasen. Når den er koblet til riktig, lyser batteriikonet.

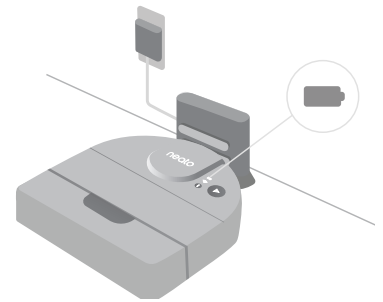

- 4 Last ned MyNeato-appen på mobilenheten din.

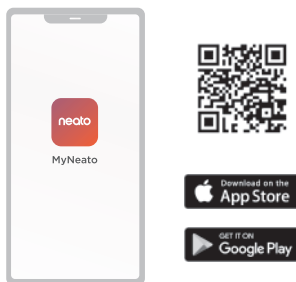

- 5 Kontroller innstillingen på mobilenheten din for å forsikre deg om at Bluetooth er slått på.

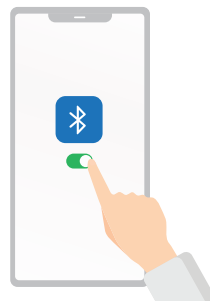

- 6 Fullfør konfigurasjonsprosessen med MyNeato-applikasjonen.



Nyttige tips

Forbered huset

Før roboten begynner å støvsuge, plukk opp gjenstander som kan bli tilfloket, for eksempel ledninger, sokker og skolisser. Brett frynser inn under tepper.

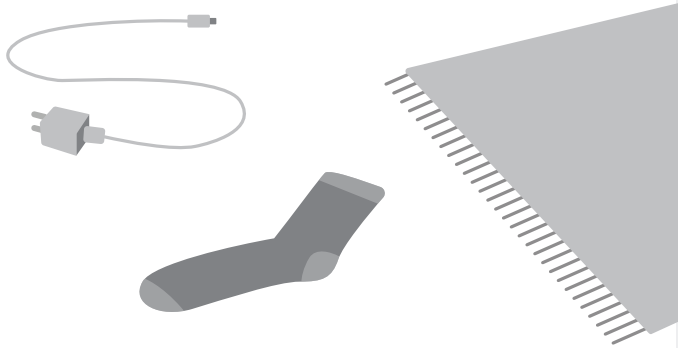

Hold ladebasen sikker

Ladebasen kommer med en pute som er utformet for å holde den sikker på et tregulv. Fjern disse putene hvis du planlegger å sette ladebasen på teppe.

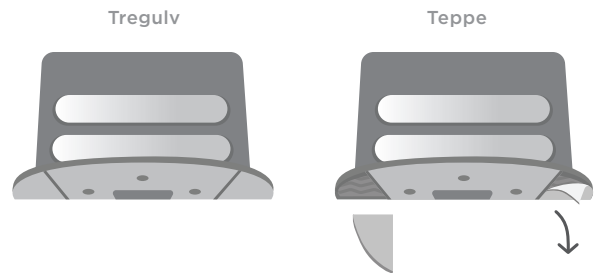

Rengjør med MyNeato-appen.

Bruk MyNeato-appen til å:

- Lag en tidsplan for roboten
- Vis rengjøringskart
- Sett opp soner der roboten ikke skal gå



Trenger du hjelp?

Finn ut mer om roboten:
www.NeatoRobotics.com/UG

Vi er her for å hjelpe. Kontakt oss på
www.NeatoRobotics.com/contact-us



Pikaopas

- 1 Kytke liitin latausaseman takaosaan. Lyhennä johtoa tarvittaessa kiertämällä se latausaseman takaosaan.

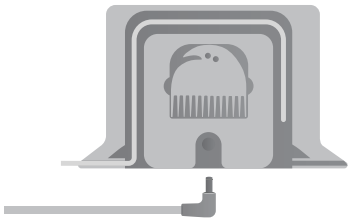

- 2 Valitse tyhjä alue, johon Wi-Fi-yhteys yltää hyvin. Varmista, että latausasema on seinää vasten ja kytketty pistorasiaan.

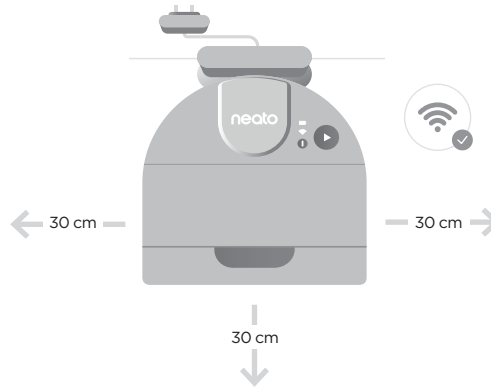

- 3 Aseta robotti latausasemaa vasten. Oikein telakoituna akkukuvakkeen valo syttyy.

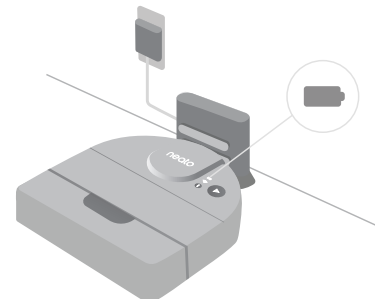

- 4 Lataa MyNeato-sovellus mobiililaitteeseen.



- 5 Tarkista mobiililaitteen asetus ja varmista, että Bluetooth on kytketty.

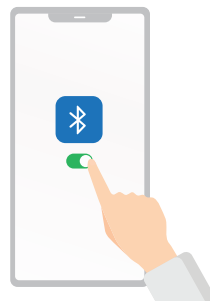

- 6 Viimeistele asennusprosessi MyNeato-sovelluksella.



Hyödyllisiä vinkkejä

Valmistele koti

Ennen kuin robotti alkaa imuroida, poimi pois esineet, jotka voisivat sotkeutua robottiin, kuten johdot, sukat ja kengännauhat. Työnnä hapsut mattojen alle.

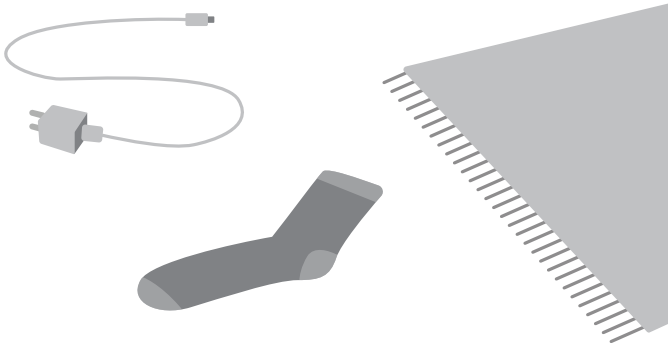

Pidä latausasema paikallaan

Latausaseman mukana on alusta, jonka tarkoitus on pitää asema paikallaan parkettilattialla. Poista alustat, jos aiot asettaa latausaseman maton päälle.

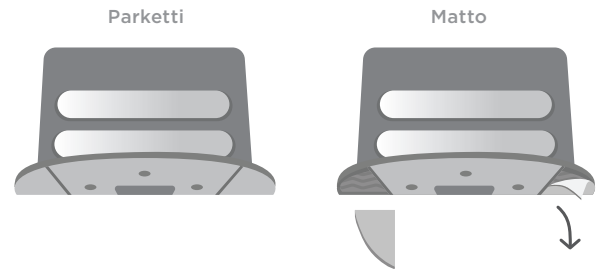

Imuroi MyNeato-sovelluksen avulla

Käytä MyNeato-sovellusta seuraaviin tarkoituksiin:

- Robotin ajastus
- Siivouskarttojen tarkastelu
- Luo kiellettyjä alueita



Tarvitsetko apua?

Lue lisää robotistasi:
www.NeatoRobotics.com/UG

Olemme valmiit auttamaan.
Ota yhteys osoitteessa
www.NeatoRobotics.com/contact-us

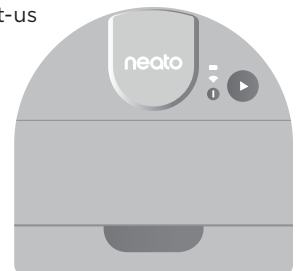

Stručná příručka

- 1 Zasuňte zástrčku do zadní strany nabíjecí základny. Podle potřeby kabel zkraťte jeho svázáním za nabíjecí základnou.

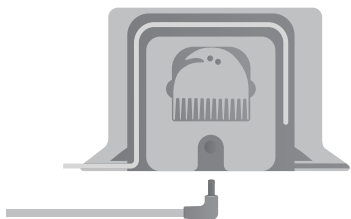

- 2 Vyberte volnou oblast s dobrým pokrytím Wi-Fi. Zajistěte, aby byla nabíjecí základna umístěna proti zdi a zapojená do zásuvky.

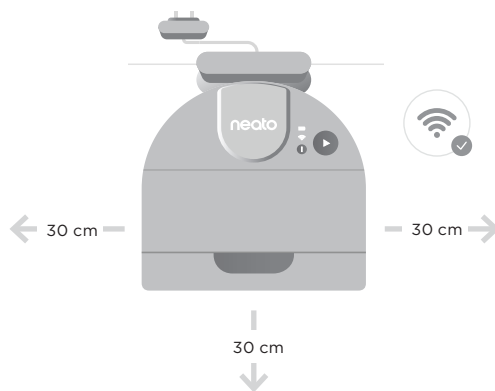

- 3 Umístěte robot proti nabíjecí základně. Při správném dokování se rozsvítí ikona baterie.

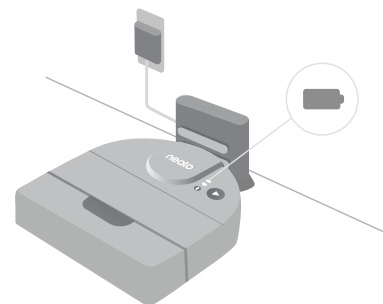

- 4 Stáhněte si aplikaci MyNeato.

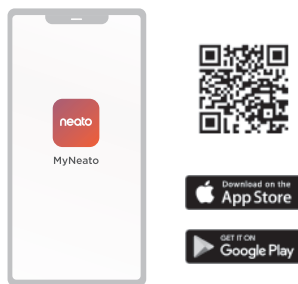

- 5 Zkontrolujte nastavení svého mobilního zařízení a ujistěte se, že je Bluetooth zapnuté.

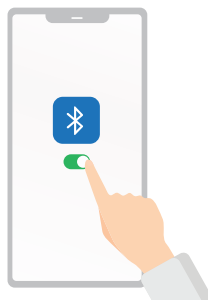

- 6 Dokončete proces nastavení s aplikací MyNeato.



Užitečné rady

Nastavte svůj dům.

Než začne robot vysávat, seberte předměty, které by se mohly zamotat, jako jsou kabely, ponožky a tkaničky. Třásně zastrčte pod koberečky.

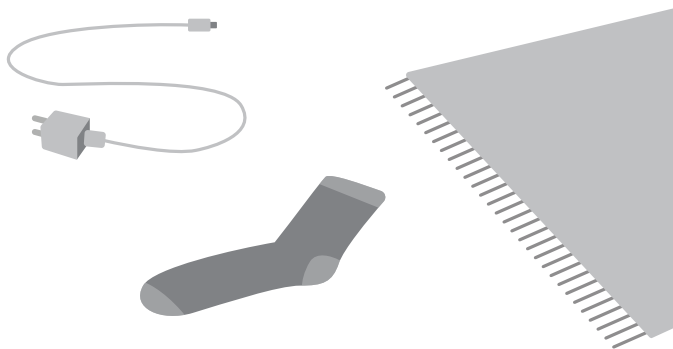

Udržujte svou nabíjecí základnu zabezpečenou.

Nabíjecí základna je dodávána s podložkou, která brání jejímu klouzání na tvrdé podlaze. Pokud plánujete umístit nabíjecí základnu na koberec, tuto podložku odstraňte.

Tvrdá podlaha



Koberec

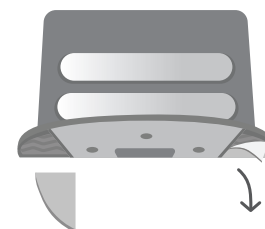

Čištění pomocí aplikace MyNeato

Aplikace MyNeato umožňuje:

- plánovat činnosti robota,
- zobrazovat mapy čištění,
- vytvářet oblasti se zákazem vstupu.

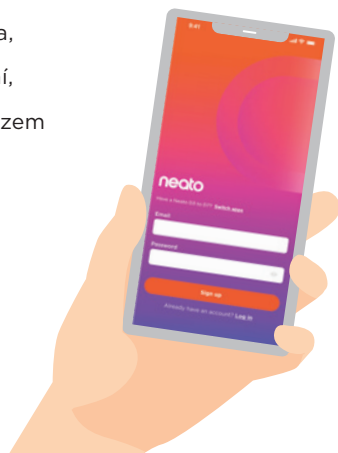

Potřebujete pomoc?

Více informací o vašem robotu:
www.NeatoRobotics.com/UG

Jsme zde, abychom vám pomohli. Kontaktujte nás na adrese:
www.NeatoRobotics.com/contact-us



Skrócona instrukcja obsługi

- 1 Włóż wtyczkę z tyłu stacji ładującej. W razie potrzeby skróć przewód, zwijając go za stacją ładującą.

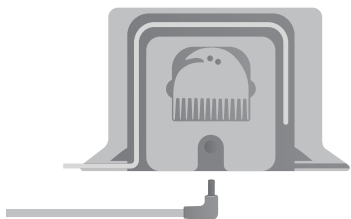

- 2 Wybierz obszar wolny od przeszkód, o dobrym zasięgu Wi-Fi. Upewnij się, że stacja ładująca jest podłączona do prądu i stoi przy ścianie.

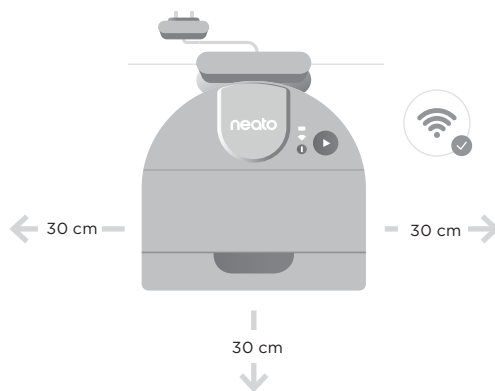

- 3 Oprzyj robota o stację ładującą. Po prawidłowym zadokowaniu ikona baterii zacznie się świecić.

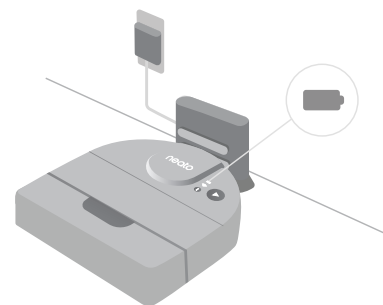

- 4 Pobierz aplikację MyNeato.

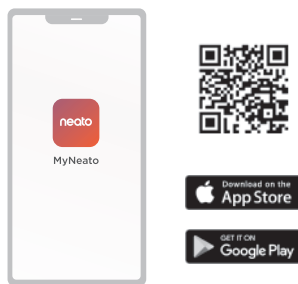

- 5 Sprawdź ustawienia swojego urządzenia, aby upewnić się, że funkcja Bluetooth jest włączona.

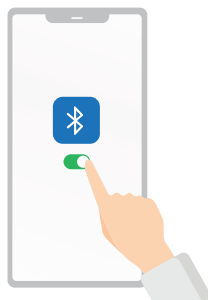

- 6 Zakończ proces konfiguracji w aplikacji MyNeato.



Przydatne wskazówki

Przygotuj mieszkanie

Zanim robot zacznie odkurzać, pozbieraj przedmioty, które mogą się zaplątać, takie jak kable, skarpetki i sznurowadła. Schowaj frędzle pod dywan.

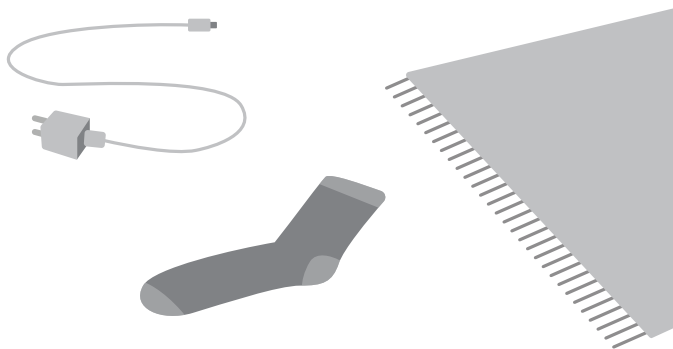

Ustaw stację ładującą

Stacja ładująca jest wyposażona w podkładki przytrzymujące ją bezpiecznie na drewnianej podłodze. Zdejmij je, jeśli stacja ładująca ma leżeć na dywanie.

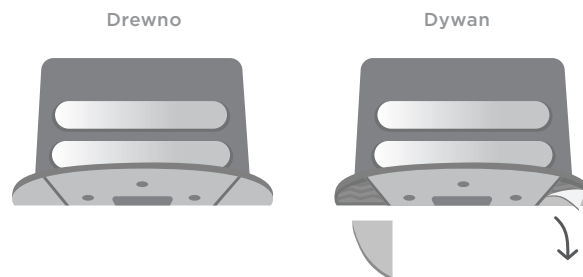

Odkurzaj z aplikacją MyNeato

Użyj aplikacji MyNeato w celu:

- Zaplanowania pracy robota
- Wyświetlenia map odkurzania
- Tworzenia stref zakazu wstępu



Potrzebujesz pomocy?

Dowiedz się więcej o swoim robocie:
www.NeatoRobotics.com/UG

Służymy pomocą. Skontaktuj się z nami:
www.NeatoRobotics.com/contact-us



Gyorsútmutató

- 1 Dugja be a csatlakozót a töltőállomás hátsó részén. Szükség szerint állítsa rövidebbre a kábelt a töltőállomás mögött feltekerve azt.

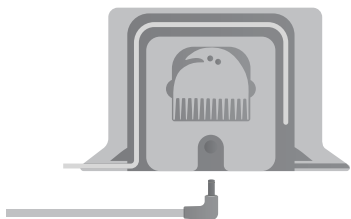

- 2 Válasszon egy üres területet, ahol jó a Wi-Fi-lefedettség. Ügyeljen arra, hogy a töltőállomás a fal mellé legyen helyezve, és be legyen dugva.

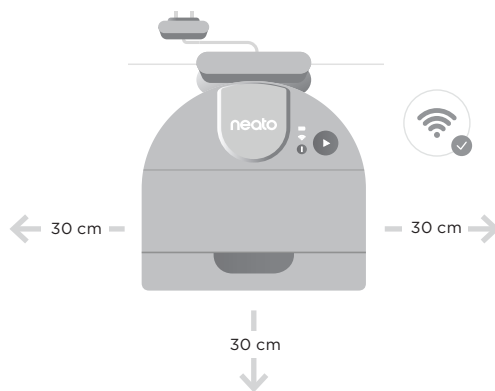

- 3 Helyezze a robotot a töltőállomásra. Megfelelő dokkolás esetén az elem ikon világitani kezd.

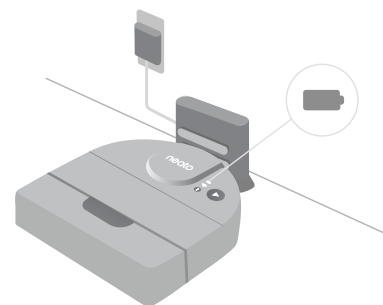

- 4 Töltse le a MyNeato alkalmazást.

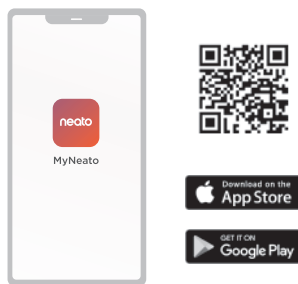

- 5 Ellenőrizze a mobilkészítő beállításait, és győződjön meg arról, hogy a Bluetooth be van kapcsolva.

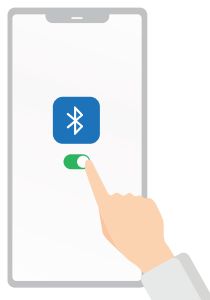

- 6 Fejezze be a beállítási folyamatot a MyNeato alkalmazásban.



Hasznos tanácsok

Rakjon rendet az otthonában

Mielőtt a robot megkezdené a porszívózást, távolítsa el a padlóról azokat a tárgyakat, amelyekbe belegabalyodhat, mint például kábelek, zoknik és cipőfűzők. A rojtokat hajtja be a szőnyegek alá.

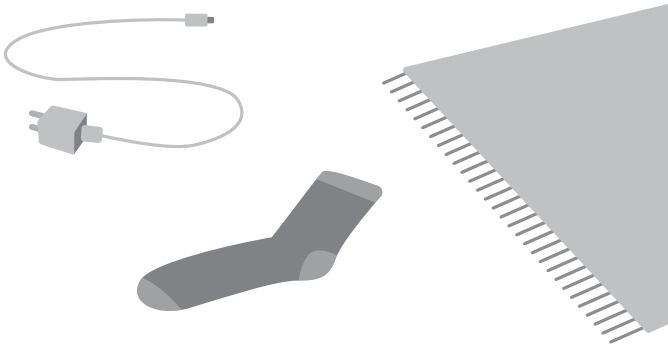

Stabilan helyezze el a töltőállomást

A töltőállomás olyan talpakkal rendelkezik, melyeket arra terveztek, hogy fapadlón stabilan tartsák azt. Ha a töltőállomást szőnyegen szeretné elhelyezni, távolítsa el ezeket a talpakat.

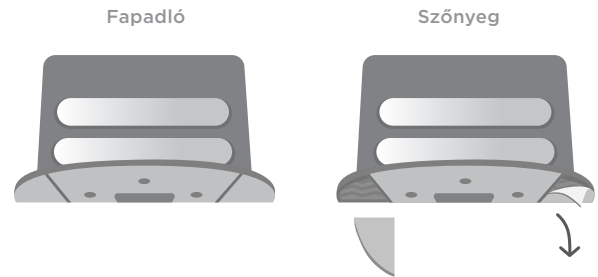

Takarítson a MyNeato alkalmazással

A MyNeato alkalmazással:

- Beütemezheti robotja működését
- Megtekintheti a takarítási térképeket
- Tiltott területeket alakíthat ki

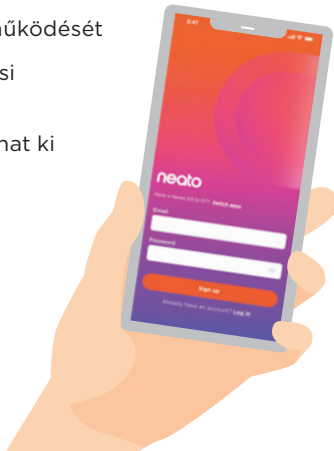

Segítségre van szüksége?

További információ a robotjáról:

www.NeatoRobotics.com/UG

Azért vagyunk itt, hogy segítsünk. Elérhetőségünk:

www.NeatoRobotics.com/contact-us



Neato Robotics®, Inc.
50 Rio Robles
San Jose, CA 95134, USA

Neato B.V.
WTC Schiphol Airport, Toren D
Schiphol Boulevard 359
1118 BJ Schiphol, Netherlands

NeatoRobotics.com



P/N 515-0095 Rev A